

Technical datasheet

SQEA-M-840-1



Product description

Square easy is a 595x595 mm LED panel with state-of-the-art LED technology and LED source with 50,000 hours lifetime. Available in 3 power options, color temperatures 3000K/4000K with CRI 80+. Steel body with PMMA diffuser for optimal light distribution and DALI control option available. Fully compatible with existing lighting infrastructure. Ideal for offices, halls and commercial spaces. 5-year warranty.

LED 220-240 V IP20   UGR < 19 CCT 4000 k CRI 80+

Product technical data

Mains voltage	220 - 240V AC, 50/60Hz	Optical system	Diffuser
Connection method	Plug-in terminal	Optical part material	PMMA
Dimming type	Non-dimmable	Housing material	Steel
IP rating	20	Surface finish	Powder coated
Protection class	II	Service lifetime (L80 B10)	50 000 h
Ambient temperature	0 to +30 °C	Warranty	5 years
Light source	LED		
Colour temperature	4000k		
Color rendering index	80		
Rated luminous flux	4,160 lm		
Connected load	26.00 W		
Luminous efficacy	160.0 lm/W		

Dimensions

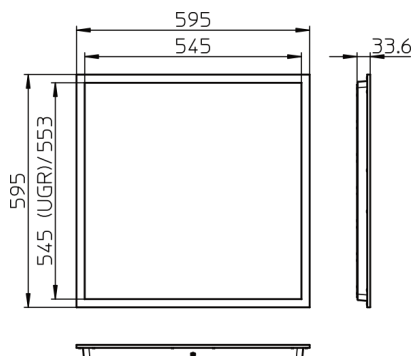

Light distribution

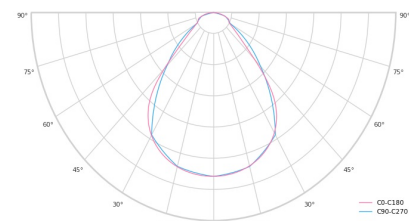

Optional products



Square Easy
frame

Square springs
Code: SQ Springs

Square
suspension kit
