

Technical datasheet

DIABLO-S-935-1-15-BL



Product description

Diablo is a compact 3-phase LED spotlight with integrated power supply and aluminum heatsink with 50,000 hours lifetime. Available in 3 power options, wide range of color temperatures (2700K-4000K) with CRI 80+/90+. Four light distribution types (15°, 24°, 36°, 60°) and DALI control option available. Ideal for commercial spaces, showrooms and households. 5-year warranty.

LED 220-240V
50-60Hz **IP20**  **CE**  **CCT**
3500 K **CRI**
90+

Product technical data

Mains voltage 220 - 240V AC, 50/60Hz
Connection method 3-phase track adapter
Dimming type Non-dimmable

IP rating 20
Protection class II
Ambient temperature 0 to +25 °C

Light source LED
Colour temperature 3500k
Color rendering index 90
Rated luminous flux 1,823 lm
Connected load 13.58 W
Luminous efficacy 134.3 lm/W

Ripple 5 %
Inrush current 7 A
Inrush time 28 µs

Optical system Lenses
Optical part material PMMA
Housing material Die-cast aluminium
Surface finish Powder coated

Height 132.00 cm
Diameter 90.00 cm
Weight 0.80 kg

Service lifetime (L80 B10) 50 000 h
Warranty 5 years

Dimensions

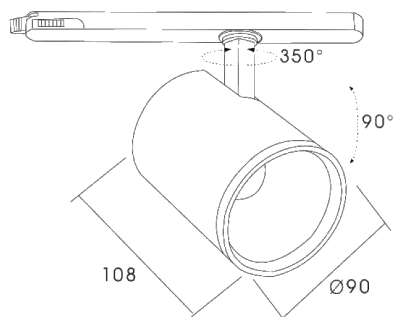

Light distribution

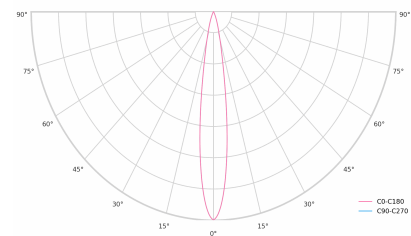

Optional products



PRO-0410



PRO-0420



PRO-0431L



PRO-0431R



PRO-0432



PRO-0433



PRO-0434



PRO-0437



PRO-04SK



PRO-D680-B



PRO-D680-W



PRO-EZ0449



PRO-EZ0450



PRO-M435



PRO-M436



PRO-M438

PRO-MD636L

PRO-MD638