

# Technical datasheet

LUKA-XL-740-2-C13604



## Product description

Luka emits reliably efficient light on traffic roads and industrial areas to support safety and security outdoors. The smart function also offers a range of smart city functions.



## Product technical data

Mains voltage	220 - 240V AC, 50/60Hz	Ripple	3 %
Connection method	Connection cable	DALI address	1
Dimming type	DALI	Standby power	0.50 W
IP rating	66	Inrush current	85 A
Protection class	I	Inrush time	256 µs
Ambient temperature	-40 to +40 °C	Optical system	Lenses
Light source	LED	Optical part material	Hardened glass
Colour temperature	4000k	Housing material	Die-cast aluminium
Color rendering index	70	Surface finish	Powder coated
Rated luminous flux	7,635 lm	Service lifetime (L80 B10)	>100 000 h
Connected load	56.50 W	Warranty	5 years
Luminous efficacy	135.1 lm/W		

## Dimensions

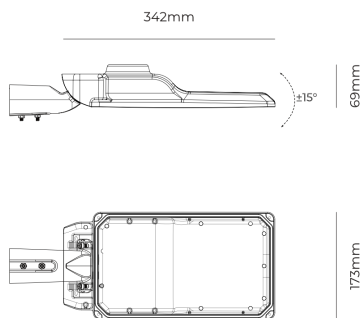

## Light distribution

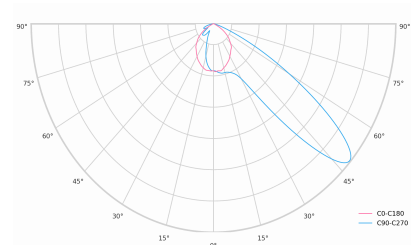

### Constant Light Output (CLO)

This system compensates for the depreciation of luminous flux to avoid excess lighting at the beginning of the installation's service life. Luminous depreciation over time must be taken into account to ensure a predefined lighting level during the luminaire's useful life.

Without a CLO feature, this simply means increasing the initial power upon installation in order to make up for luminous depreciation. By precisely controlling the luminous flux, the energy needed to reach the required level can be maintained throughout the luminaire's life.



A. Dimming level  
B. Time

### DALI 2

DALI (Digital Addressable Lighting Interface) is an international standard for digital lighting control systems. It enables individual control of each luminaire in the network using digital signals - unlike traditional analog solutions.

**Key DALI2 innovations:**

- Advanced diagnostic capabilities
- Better fault reporting and device status
- Enhanced scene programming options
- Support for RGB/RGBW and tunable white

### MidNight function

The MidNight function feature allows an autonomous dimming without the need for an additional control line. The output levels can be set to 0% (OFF) or between 10% and 100% in steps of 1%

**Time-based:** The dimming profile defined in the reference schedule is referenced to the switch on time of the LED driver.

**Astro-based:** The dimming profile defined in the reference schedule is referenced to the annual average middle of the night, which is calculated based on the theoretical sunrise and sunset times.



1. Standard lighting level  
2. LED lighting consumption with CLO  
3. Energy savings