

# Technical datasheet

## LUKA-L-740-1-C13301



### Product description

Luka emits reliably efficient light on traffic roads and industrial areas to support safety and security outdoors. The smart function also offers a range of smart city functions.



**LED** 220-240V 50-60Hz **IP66**  **CE** **CCT 4000 k** **CRI 70+** **CLO** 

### Product technical data

Mains voltage	220 - 240V AC, 50/60Hz	Ripple	3 %
Connection method	Connection cable	Inrush current	46 A
Dimming type	Non-dimmable	Inrush time	728 μs
IP rating	66	Optical system	Lenses
Protection class	I	Optical part material	Hardened glass
Ambient temperature	-40 to +40 °C	Housing material	Die-cast aluminium
Light source	LED	Surface finish	Powder coated
Colour temperature	4000k	Width	173.00 cm
Color rendering index	70	Height	69.00 cm
Rated luminous flux	5,512 lm	Length	342.00 cm
Connected load	50.70 W	Weight	5.00 kg
Luminous efficacy	108.7 lm/W	Service lifetime (L80 B10)	>100 000 h
		Warranty	5 years

### Dimensions

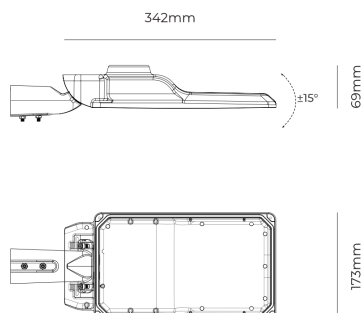

### Light distribution

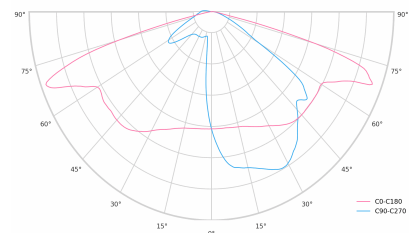

### Constant Light Output (CLO)

This system compensates for the depreciation of luminous flux to avoid excess lighting at the beginning of the installation's service life. Luminous depreciation over time must be taken into account to ensure a predefined lighting level during the luminaire's useful life.

Without a CLO feature, this simply means increasing the initial power upon installation in order to make up for luminous depreciation. By precisely controlling the luminous flux, the energy needed to reach the required level can be maintained throughout the luminaire's life.



A. Dimming level  
B. Time

### MidNight function

The MidNight function feature allows an autonomous dimming without the need for an additional control line. The output levels can be set to 0% (OFF) or between 10% and 100% in steps of 1%.

**Time-based:** The dimming profile defined in the reference schedule is referenced to the switch-on time of the LED driver.

**Astro-based:** The dimming profile defined in the reference schedule is referenced to the annual average middle of the night, which is calculated based on the theoretical sunrise and sunset times.



1. Standard lighting level  
2. LED lighting consumption with CLO  
3. Energy savings